

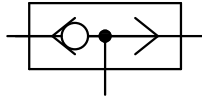

## VÁLVULA SELECTORA DE CIRCUITO FUNCIÓN "O"

VAN - 356 - XX - 2

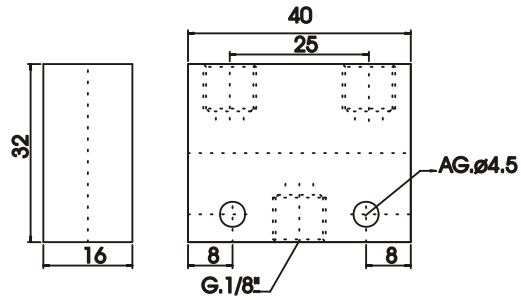

## VÁLVULAS DE SIMULTANEIDAD FUNCIÓN "Y"

VAN - 357 - XX - 2

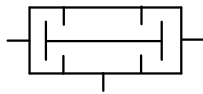
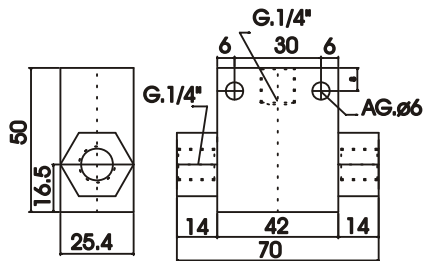
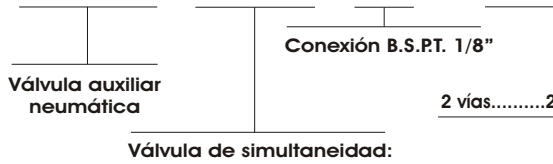

## VÁLVULA COLIZANTE 3/2

VC - XX - 2

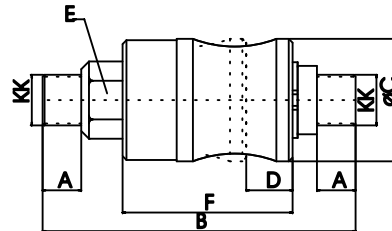
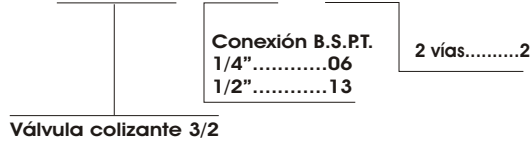

KK	A	B	C	D	E	F
1/4"	10	81	31,7	12	19	44
1/2"	15	120	44	22,5	25,4	67

## VÁLVULA ESFÉRICA PARA USO NEUMÁTICO E HIDRÁULICO

VE - XX - 2

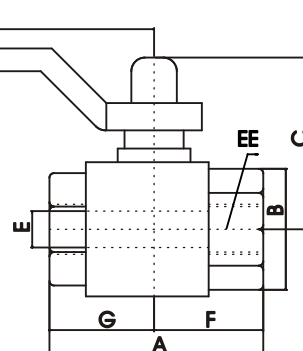
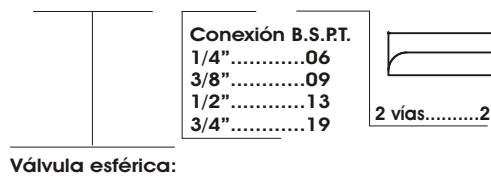

EE	A	B	C	D	E	F	G
1/4"	44,4	23,5	37	80	10	22,2	22,2
3/8"	44,4	24	37	80	10	22,2	22,2
1/2"	50,5	30,5	41	80	15	25	25,5
3/4"	57,5	37	55	113	20	28	29,5